



magnetdichtungen

kühlschrank

getränkekühlkorpus

weinklimaschrank

gn-kühlkorpus

kühlvitrine

tiefkühlkorpus

glacékonservator

schnellkühler

saladette

patisserievitrine

verkaufskorpus

pralinévitrine

kühlraumtüre

buob kühlmöbel

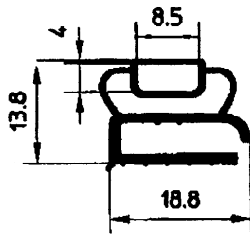

Art. N°2070
PVC Souple

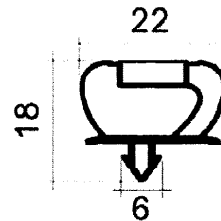

Art. N° 2350
PVC souple

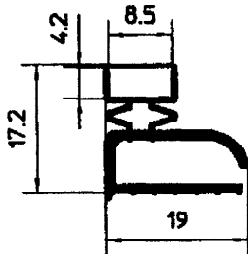

Art. N°1060
PVC Souple

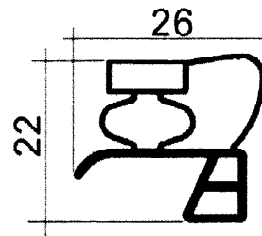

Art. N° 5010
PVC souple

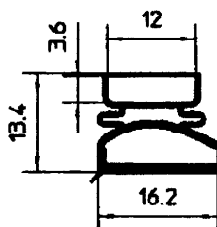

Art. N°1400
PVC Souple

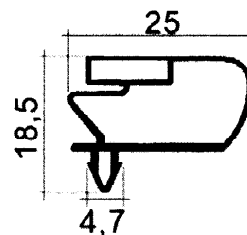

Art. N° 1045
PVC souple

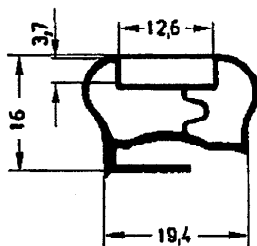

Art. N°2000
PVC Souple

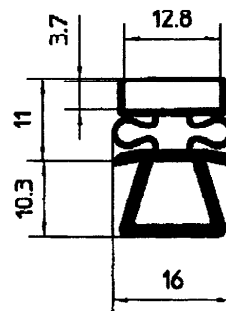

Art. N°1620
PVC Souple

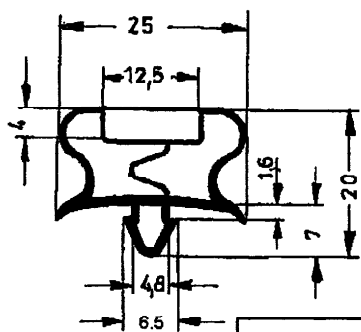

Art. N°1950

PVC Souple

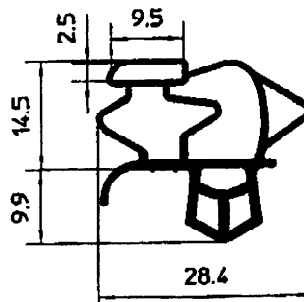

Art. N°1900

PVC Souple

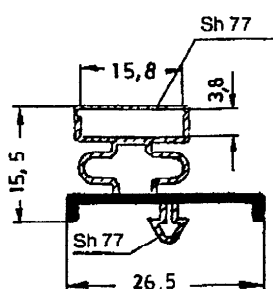

Art. N°1850

PVC Souple

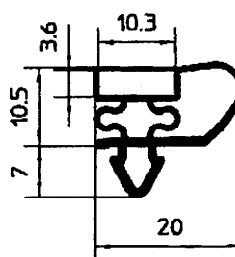

Art. N°2250

PVC Souple

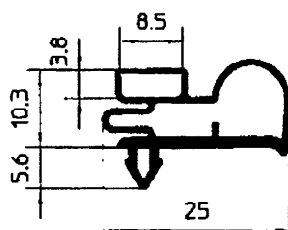

Art. N°2030

PVC Souple

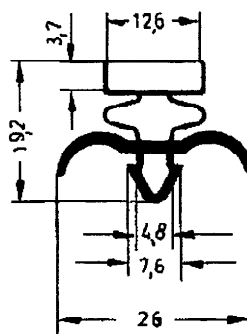

Art. N°1710

PVC Souple

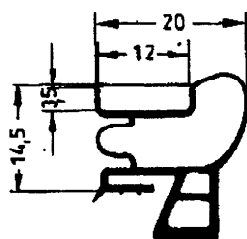

Art. N°1940

PVC Souple

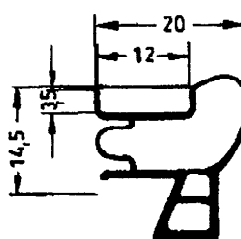

Art. N°1945

PVC Souple

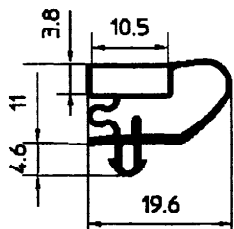

Art. N°2800
PVC Souple

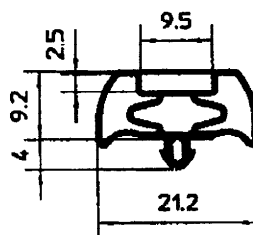

Art. N°2520
PVC Souple

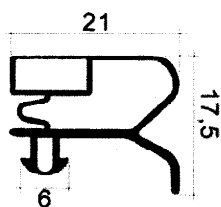

Art. N°2610
PVC Souple

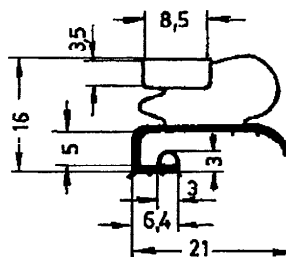

Art. N°2620
PVC Souple

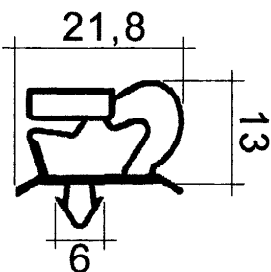

Art. N°1300
PVC Souple

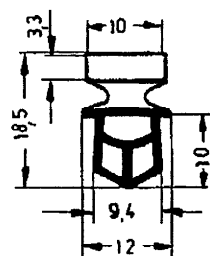

Art. N°1000
PVC Souple

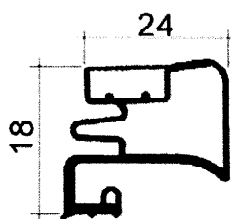

Art. N°2270
PVC Souple

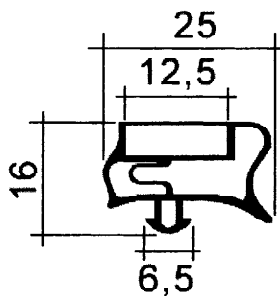

Art. N°2810
PVC Souple

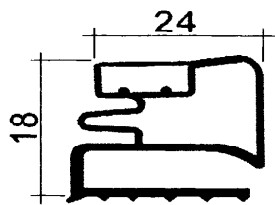

Art. N° 1270
PVC Souple

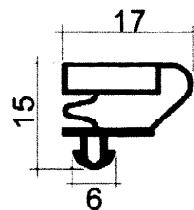

Art. N° 2200
PVC Souple

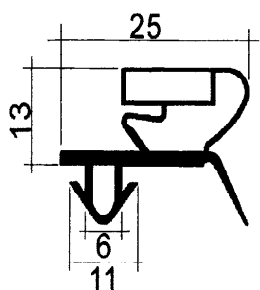

Art. N° 2080
PVC Souple

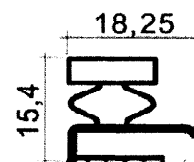

Art. N° 1030
PVC Souple

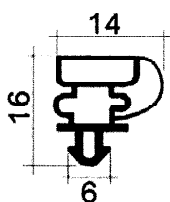

Art. N° 5600
PVC Souple

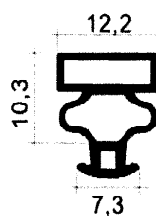

Art. N° 1450
PVC Souple

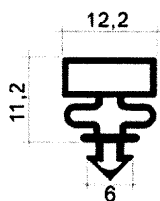

Art. N° 320
PVC Souple

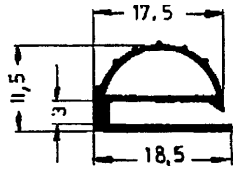

Art. N°1020
PVC Souple

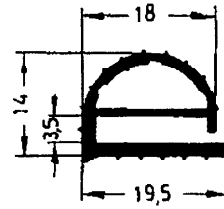

Art. N°1040
PVC Souple

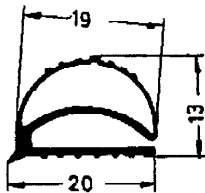

Art. N°1580
PVC Souple

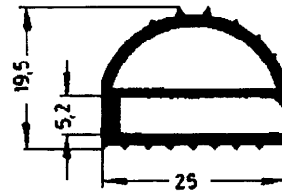

Art. N°1690
PVC Souple

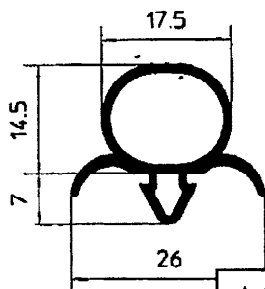

Art. N°1920
PVC Souple

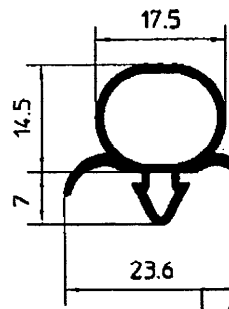

Art. N°1925
PVC Souple

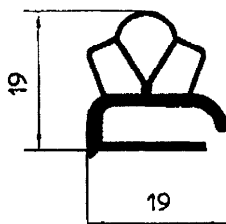

Art. N°1910
PVC Souple

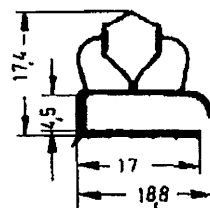

Art. N°2075
PVC Souple

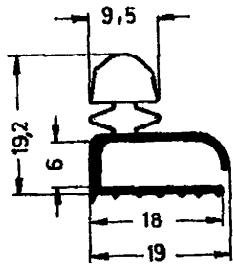

Art. N°1065
PVC Souple

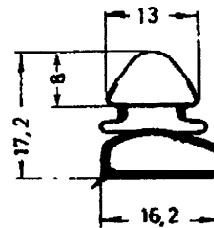

Art. N°1405
PVC Souple

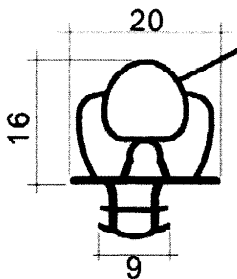

Art. N° 3000
PVC Souple

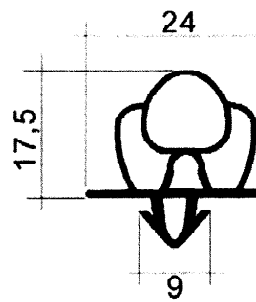

Art. N° 5500
PVC Souple

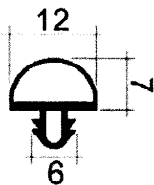

Art. N°540
PVC Souple

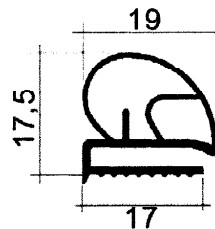

Art. N° 3140
PVC Souple

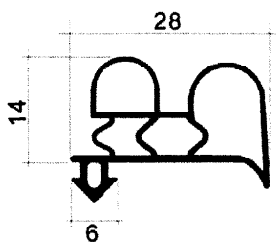

Art. N°600
PVC Souple

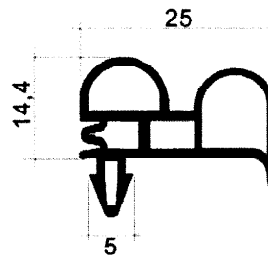

Art. N°620
PVC Souple

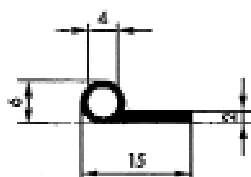

Art. N°6690

EPDM, gris

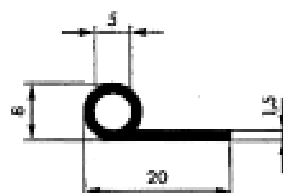

Art. N°6380

EPDM, noir



Art. N°300

EPDM, gris



Art. N°590

EPDM, gris



Art. N°2630

EPDM, gris



Art. N°2740

EPDM, gris



Art. N°2470

EPDM, gris



Art. N°2990

EPDM, noir

BESTELLUNG



buob Kühlmöbel AG
Wiesenstrasse 10
CH – 9327 Tübach

Tel: +41 (0)71 844 89 60
info@buob.ch

Menge	Profil-Nummer	Farbe	Rahmenabmessung



Magnetdichtungsmasse



Aussenmasse

Name:

Kommission:

Strasse:

Ihre Bestellnummer:

PLZ/Ort:

Ihr Besteller/in:

Tel:

Fax:

Datum/Unterschrift:

Bei 3-seitigem Rahmen in U-Form geben Sie die Masse bitte wie folgt an:

1860 x 795 x 1860 mm

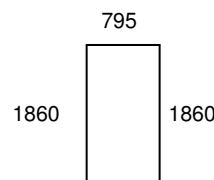

Bei 3-seitig magnetischem Rahmen muss die Seite ohne Magnet gekennzeichnet sein. Beispiel: eine Seite 890 ist Ohne Magnet, somit müssen die Rahmenmasse wie folgt angegeben werden.

515 x 890 x 890 mm

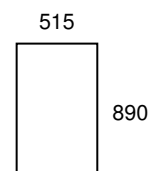

Problemlöser.

Wir lösen Ihre Probleme. Zumindest die beruflichen. Denn wie ausgefallen und kompliziert Ihre Wünsche auch immer sind - wir nehmen die Herausforderung gerne an. Und denken, planen und probieren, bis wir Ihnen eine ansprechende Lösung präsentieren können. Das dauert meistens gar nicht so lange. Unsere Spezialisten verfügen über derart viel Erfahrung und Know-how, dass Ihre Wünsche effizient verwirklicht werden.

30 MitarbeiterInnen – 1 Team.

Ein Unternehmen ist nur so gut wie seine Mitarbeiter. Umso glücklicher sind wir, dass wir über 30 erfahrene, motivierte, intelligente und kreative Spezialisten verfügen. Für sie alle ist interdisziplinäre Zusammenarbeit kein Fremdwort, sondern Alltag. Aber am besten überzeugen Sie sich selbst.

